

## 2 Handpiece Manual Control A-230

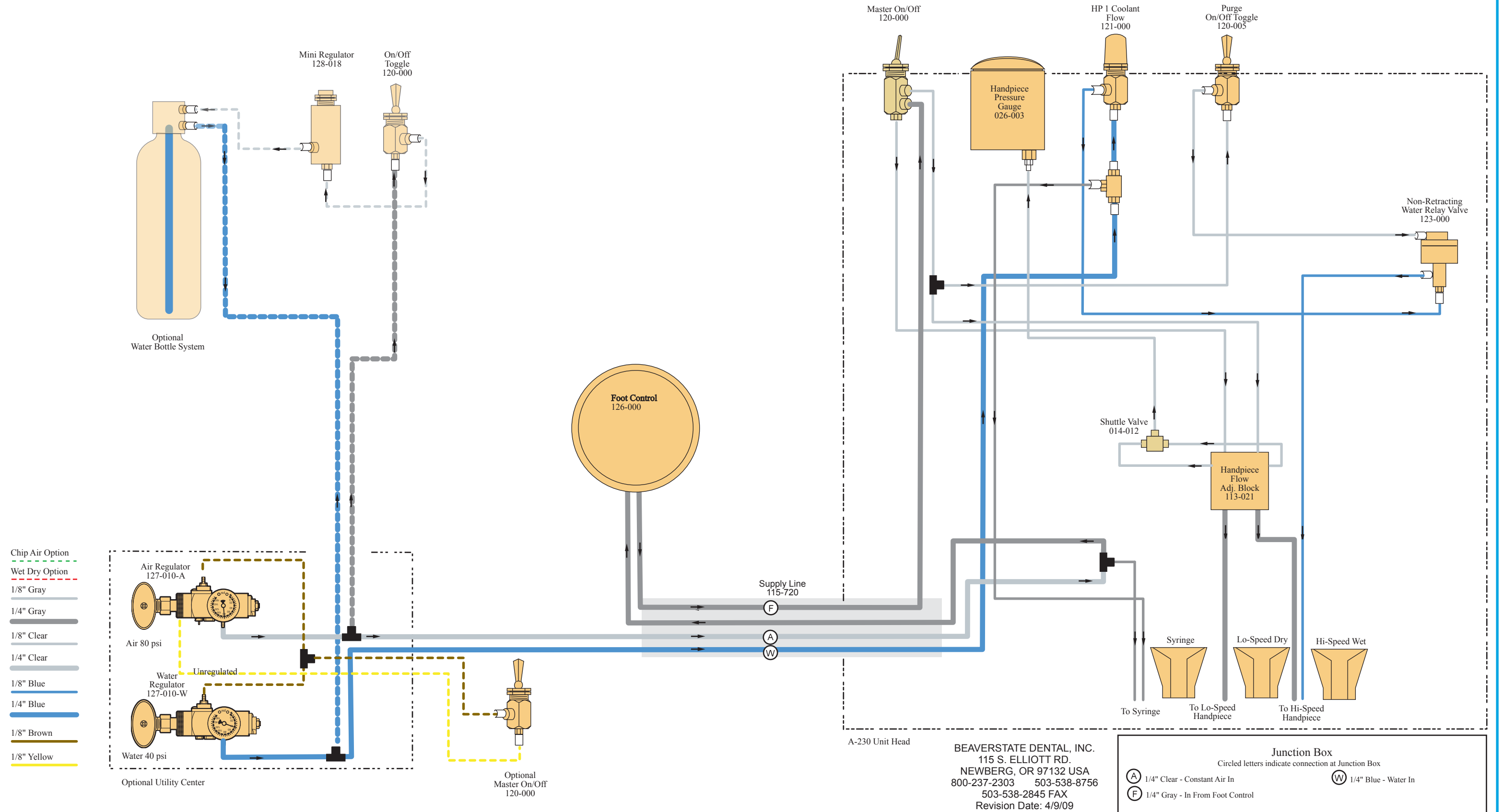

BEAVERSTATE DENTAL, INC.  
115 S. ELLIOTT RD.  
NEWBERG, OR 97132 USA  
800-237-2303 503-538-8756  
503-538-2845 FAX  
Revision Date: 4/9/09